

Owner's Manual — Phoenix R175 LGR Dehumidifier

Installation, Operation & Service Instructions

Read and Save These Instructions

The Phoenix R175 is the first roto-mold LGR (low grain refrigerant) dehumidifier manufactured by Therma-Stor, LLC. The R175 combines Phoenix innovation, technical expertise and proven durability. This unit will remove more water, produce more grain depression and dry structures and contents faster than standard refrigerant dehumidifiers.

In addition to the performance benefits, patented bypass technology and tough compact size, are the multiple ducting options, pleated media filter and energy efficient operation. The R175 is the latest member of the Phoenix line of LGR dehumidifiers; the most effective and versatile drying devices made.

The Phoenix R175 LGR Dehumidifier

Increased Capacity - The Phoenix R175 removes over 30% more water than other dehumidifiers of equal size.

Energy Efficiency - Removes 92 pints at AHAM while drawing only 6.3 amps.

Patented Bypass Technology

230 CFM - More processed air speeds drying and provides superior static pressure for ducting.

More Grain Depression - Drier from an LGR gets your jobs drier quicker.

Focused Airflow - Patent focused outlet directs air downward across the wet surface.

Multiple Ducting Options - 12" intake, 10" exhaust.

Plastic Housing - Rugged roto-molded housing resists dents and scratches.

Solid State Controls - Easy to read and operate.

Protected Condensate Hose - Located under the lid. Cannot catch or be damaged on obstructions.

Telescoping Handle - A heavy-duty retractable handle for ease of transport and reduces space for storage and stacking.

Recessed 12" Wheels - Allows greater maneuverability on the job site and efficient storage. Rolls over obstacles with ease.

Pleated Media Air Filter - A MERV-7 is standard.

Stacking/Nesting - Reduces space for ease of stacking and storage.

Patented
BYPASS
TECHNOLOGY™



Phoenix R175

Part No. 4029200

Patent 7,246,503

7,281,389

7,540,166

TS-592

10/09

Specifications subject to change without notice.

Table of Contents

Introduction	1
1. Safety Certifications	2
2. Specifications	2
3. Operation	2
3.1 Transporting	2
3.2 Electrical Requirements	3
3.3 Condensate Removal	3
3.4 Ducting	3
3.5 Defrost Cycle	3
3.6 Power Button	3
3.7 Purge Button	3
3.8 Hour Meter	3
3.9 Hours Button	3
3.10 Defrost Light	3
3.11 Bypass Control.....	3
4. Maintenance	4
4.1 Air Filter	4
4.2 Storage	4
5. Service	4
5.1 Technical Description	4
5.2 Troubleshooting	5
5.3 Air Mover	6
5.4 Thermistor	6
5.5 Condensate Pump	6
5.6 Float Safety Switch	6
6. Options & Accessories	6
7. Wiring Diagram	7
8. Service Parts	8
9. Warranty	9

Read the operation and maintenance instructions carefully before using this unit. Proper adherence to these instructions is essential to obtain maximum benefit from your Phoenix R175 dehumidifier.

WARNING

- It is designed to be used **INDOORS ONLY**.
- If used in a wet area, plug it into a **GROUND FAULT INTERRUPTER**.
- **DO NOT** use the Phoenix R175 as a bench or table.
- It must always be used in the upright position.

1 Safety Certifications

The Phoenix R175 conforms to standards ANSI/UL 474 and CSA C22.2 No.92.

2 Specifications

Part No.	4029200
Power	6.3 amps, 110-120 VAC, Grounded
Water Removal	92 pints/day @ AHAM (80°F, 60%) 21 gal/day maximum @ saturation
Blower	230 CFM without external ducting 210 CFM @ .15 IWG external static
Refrigerant Charge	1 lb, 8 oz. R410a
Operating Range	33°F to 105°F
Filter	12" x 12" x 1" Pleated Media MERV-7
Duct Options	Intake – 12" Flex-Duct Supply – 10" Lay-Flat
Warranty	Five years; 1st year 100% of Parts and Labor 2nd-5th year 100% of Parts of sealed refrigeration system.
Size	33" high x 20" wide x 20" deep
Weight	105 lbs
Patent	7,246,503 7,281,389 7,540,166

3 Operation

Place dehumidifier inside structure, place condensate hose into a drain, or a very large container, and turn on. To decrease drying times, make sure all windows and doors are closed to the outside and seal off the wet area from any unaffected areas.



Figure 1: Stacked Phoenix R175

3.1 Transporting

The Phoenix R175 features a high-impact roto-molded housing which protects the unit airways, and while loading into vehicles. The unit was designed to make it easy to stack two high. The wheels of the top unit 'nest' in the indentations of the bottom unit to provide stability. It is recommended the units are properly secured for transport. The Phoenix R175 must always be upright when transported by vehicle. It may be tipped onto its handle and back for loading and moving by hand.

3.2 Electrical Requirements

The Phoenix R175 plugs into a common grounded outlet on a 15 amp circuit. It draws 6.3 amps at 80°F, 60% RH. If used in a wet area, a ground fault interrupter (GFI) is required. If an extension cord is required, it must have a minimum of 14 gauge conductors if 25 feet long or less and 12 gauge conductors if greater than 25 feet long.

3.3 Condensate Removal

The Phoenix R175 is equipped with an internal condensate pump to remove the water that is condensed during dehumidification. This allows the condensate to be pumped 20 feet with the attached hose. If the condensate must be pumped more than 20 feet above the unit, a second pump must be added to relay the condensate. The condensate pump automatically purges for 20 seconds every four minutes. Use the PURGE button to manually remove condensation.

3.4 Ducting

A wire duct collar is supplied to allow 10" lay-flat duct to be attached to the Phoenix R175 outlet. Lay-flat plastic ducting is available; see accessories table page 6. To attach ducting to the wire duct collar, put the plastic duct end through the collar center and roll the duct end outward so that it overlaps the outside of the collar. The duct and collar may then be quickly attached to the Phoenix R175 by snapping the collar over the four exhaust tabs.

3.5 Defrost Cycle

If the low side refrigerant temperature drops due to excessive frost formation on the evaporator coil and below the temperature set point, the thermistor activates the solid-state control and defrost light. The compressor is cycled off and on by the thermistor temperature measurement. The air mover will continue to run, causing air to flow through the evaporator coil and melt the ice when the compressor is off. When the air temperature and/or humidity increases, the evaporator temperature will rise and the thermistor will end the defrost cycle at the temperature set point.

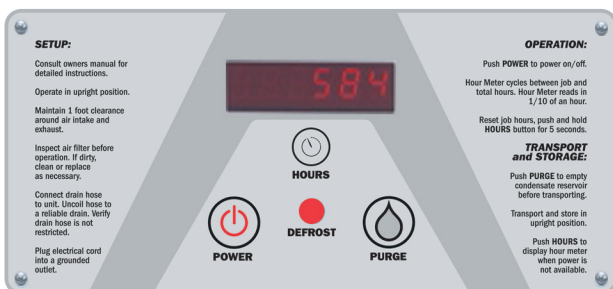

Figure 2: Phoenix R175 control board.

3.6 POWER Button

Press the POWER button to turn the dehumidifier on or off. When starting the dehumidifier the display will show the accumulated hours. Press the POWER button again to turn the dehumidifier off. The display will also power off.

3.7 PURGE Button

During normal operation the pump automatically cycles every four minutes. Press the PURGE button to remove condensate manually from the reservoir. There are several ways to manually remove water from the reservoir:

1. Press the PURGE button once and the pump will run for 20 seconds
2. Press and hold the PURGE button and the pump will run for up to 30 seconds
3. Press the PURGE button while the dehumidifier is powered off and the pump will run for 30 seconds.

Always manually purge the water reservoir before transport or storage. Turn off the power and allow the plugged in dehumidifier to rest 15 minutes before the final purge.

3.8 Hour Meter

The digital hour meter displays the cumulative and job time the dehumidifier has been turned on to the tenth of an hour. The total and job hours measured is stored when the unit is unplugged. The previous total will be displayed the next time the unit is turned on. The job hours can be reset by pressing and holding the HOURS button for 5 seconds when the unit is operating.

3.9 HOURS Button

Press the HOURS button when the dehumidifier cannot be plugged in and the hour meter needs to be read. The digital hour meter will display the last saved cumulative time for ten seconds.

3.10 DEFROST Light

The DEFROST light turns on when the unit is in defrost cycle and indicates when the compressor is off.

3.11 Bypass Control

Below 90°F - When operating the Phoenix R175 below 90°F, the bypass cover must close the bypass holes, figure 3. This maximizes the amount of air that is dehumidified across the evaporator. These cooler temperatures are often found during the first 24 hours of a drying job.

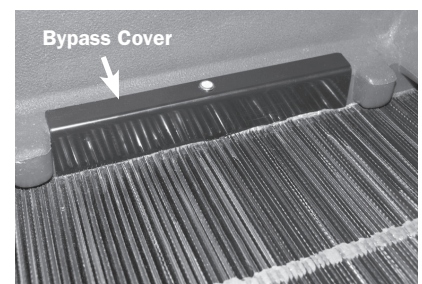

Figure 3

Above 90°F - When operating the Phoenix R175 above 90°F, reposition the bypass cover to open the bypass holes, figure 4. This improves dehumidifier efficiency by increasing the amount of airflow across the condenser. This also slows airflow across the evaporator giving the hotter air more time to reach dew point, thereby increasing dehumidifier capacity. These higher temperatures are often found after the first 24 hours of a drying job.

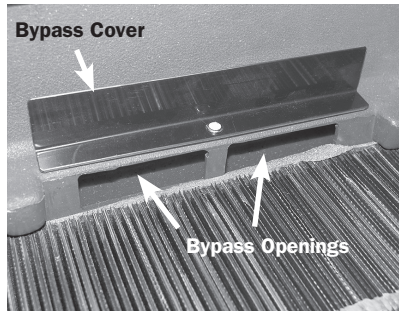
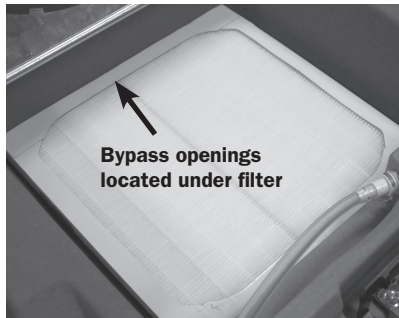

Figure 4



Remove filter, snap bypass cover into position shown, and replace filter.

4 Maintenance

4.1 Air Filter

The Phoenix R175 is equipped with a pleated media air filter that must be checked regularly. The standard filter is a MERV-7 high efficiency filter. Operating the unit with a dirty filter will reduce the dehumidifier's capacity and efficiency and may cause the compressor to cycle off and on unnecessarily. The filter can generally be vacuumed clean several times before needing replacement. Replacement filters can be ordered from the manufacturer or purchased locally if available.

! IMPORTANT

IMPORTANT: DO NOT operate the unit without the filter or with a less effective filter as the heat exchanger and coils inside the unit could become clogged and require disassembly to clean.

4.2 Storage

There are two issues to consider when the Phoenix R175 is stored between uses and both pertain to the water trapped in the unit: damage caused by freezing or biological growth. The effect of the trapped water can be greatly reduced if precautions are taken to remove as much as possible before storage.

1. Use the pump PURGE button to reduce the water level in the reservoir
2. Walk out the hose to drain it completely

In order to reduce biological growth flush the unit with

a biofungicide that is approved for use with copper, aluminum, polyethylene and ABS. To flush:

1. Run the hose to a drain
2. Plug in the unit but do not turn it on
3. Remove the air filter. Slowly pour a pint of the chemical through the top so that it drains into the heat exchanger
4. Use PURGE button to remove chemicals in reservoir. Run PURGE until hose runs dry
5. Walk out hose to drain completely
6. Replace air filter

5 Service

! WARNING

WARNING: Servicing the Phoenix R175 with its high pressure refrigerant system and high voltage circuitry presents a health hazard which could result in death, serious bodily injury, and/or property damage. Only qualified service people should service this unit.

! CAUTION

CAUTION: Do not operate unit without the front housing in place.

5.1 Technical Description

The Phoenix R175 uses a refrigeration system similar to an air conditioner's to remove heat and moisture from incoming air and to add heat to the air that is discharged.

Hot, high pressure refrigerant gas is routed from the compressor to the condenser coil. The refrigerant is cooled and condensed by giving up its heat to the air that is about to be discharged from the unit. The refrigerant liquid then passes through a filter/drier and capillary tubing which cause the refrigerant pressure and temperature to drop. It next enters the evaporator coil where it absorbs heat from the incoming air and evaporates.

The evaporator operates in a flooded condition, which means that all the evaporator tubes contain liquid refrigerant during normal operation. A flooded evaporator should maintain constant pressure and temperature across the entire coil, from inlet to outlet.

The mixture of gas and liquid refrigerant enter the accumulator after leaving the evaporator coil. The accumulator prevents any liquid refrigerant from reaching the compressor. The compressor evacuates the cool refrigerant gas from the accumulator and compresses it to a high pressure and temperature to repeat the process.

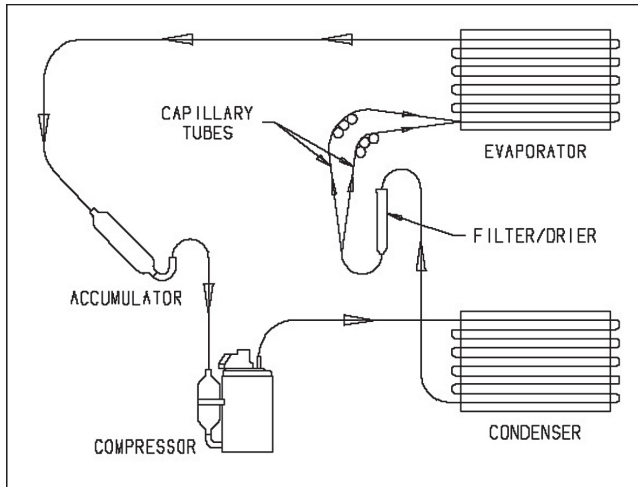

Figure 5: Refrigeration system

5.2 Troubleshooting

No dehumidification, neither hour meter display nor compressor run and POWER button does not turn ON.

1. Unit unplugged or no power to outlet
2. Defective control board
3. Loose connection in internal wiring

No dehumidification, neither hour meter display nor compressor run with POWER button ON.

1. Defective control board
2. Loose connection in internal wiring

Some dehumidification, air mover runs continuously but compressor only runs sporadically.

1. Unit is in defrost cycle, DEFROST light on
2. Defrost thermistor defective or loose
3. Loose connection in compressor circuit
4. Defective compressor overload
5. Defective compressor
6. Defective relay
7. Upper housing is not sealed to lower housing

No dehumidification, air mover runs but compressor does not.

1. Bad connection in compressor circuit
2. Safety float switch closed, check pump reservoir
3. Defective compressor capacitor
4. Defective compressor overload
5. Defective compressor
6. Defective control board

Air mover does not run. Compressor runs briefly but cycles on and off.

1. Loose connection in blower circuit
2. Obstruction prevents impeller rotation
3. Defective air mover

Unit removes some water but not as much as expected.

1. Air temperature and/or humidity have dropped
2. Humidity meter and/or thermometer used are out of calibration
3. Unit has entered defrost cycle
4. Air filter dirty
5. Defective defrost thermistor
6. Low refrigerant charge
7. Air leak such as loose cover
8. Defective compressor
9. Restrictive exhaust or inlet ducting

Unit runs but does not pump water.

1. Hose kinked or plugged
2. Pump motor defective
3. Pump check valve plugged
4. Bad connection in pump circuit
5. Hose disconnected internally
6. Defective control board (pump phase)

Unit pumps water automatically but not when PURGE button is pushed.

1. Bad connection in PURGE button circuit
2. Defective control board

Evaporator coil frosted continuously, low dehumidifying capacity.

1. Defrost thermistor loose or defective
2. Low refrigerant charge
3. Dirty air filter or restricted air flow
4. Upper housing is not sealed to lower housing

Compressor runs with POWER button OFF.

1. Defective relay
2. Defective control board
3. Upper housing not sealed to tower

No hour meter display when the HOURS button is pressed.

1. Unit is plugged in
2. Battery charge is low. Replace battery
3. Defective control board

5.3 Air Mover

The motorized impeller has a PSC motor and internal thermal overload protection. If defective, the complete assembly must be replaced.

1. Unplug power cord
2. Remove the four screws attaching the bottom plate to the lower housing
3. Disconnect the impeller leads
4. Remove the four screws holding the impeller to the bottom plate
5. Reassemble the new impeller using the above procedure in reverse

5.4 Thermistor

The defrost thermistor is attached to the refrigerant suction line between the accumulator and the evaporator.

To replace thermistor:

1. Unplug the dehumidifier
2. Remove the front housing
3. Cut cable ties and remove aluminum tape.
4. Remove control panel
5. Unthread thermistor from control housing grommet
6. Detach thermistor from control board jumper, J1
7. Reassemble thermistor and dehumidifier using the above procedure in reverse

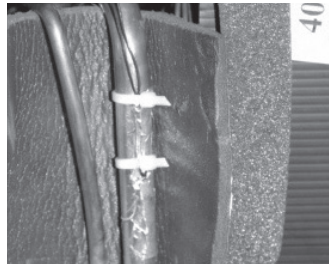

Figure 6: Thermistor attached to the refrigerant line.

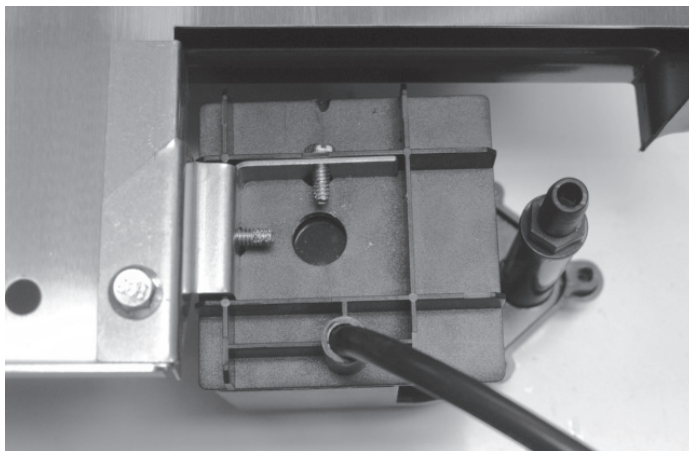

Figure 7: Picture of pump and reservoir.

5.5 Condensate Pump

The internal condensate pump removes water that collects in the reservoir.

To replace the condensate pump:

1. Unplug the unit
2. Remove the front housing
3. Unplug the pump wires from the wire harness

4. Remove the condensate hose and the one screw attaching the pump bracket to the compressor support
5. Replace the pump, hose, wiring, bolts, and housing in the reverse order

5.6 Float Safety Switch

The float safety switch activates when the water rises too high in the condensate reservoir. The float safety switch turns off the compressor until the water level lowers and disengages the switch.

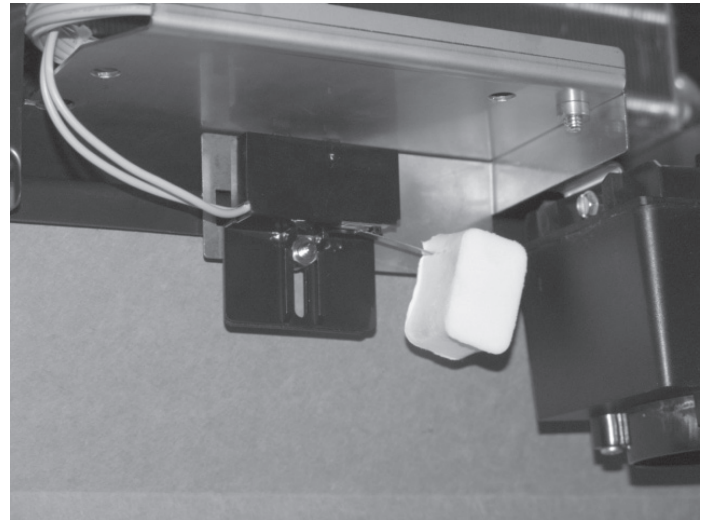

Figure 8: Picture of the float safety switch

To replace the float safety switch

1. Unplug the dehumidifier
2. Remove the front housing
3. Unplug the float safety switch wires from the wire harness
4. Remove the one screw attaching the pump and float switch bracket to the compressor support
5. Remove the pump from the reservoir and slide out the float switch from under the compressor support
6. Replace the float, pump, wiring, bolts and housing in the reverse order

6 Options & Accessories

- | | |
|---------|---|
| 4025568 | Air Filter, Pleated 12" x 12" x 1" MERV-11 |
| 4024750 | Intake Flex Duct 12" x 25"
Metallize Polyester |
| 4024935 | Lay-Flat Duct 10" Round x 250' Roll |

To order, contact Therma-Stor LLC at 1-800-533-7533.

7 Wiring Diagram

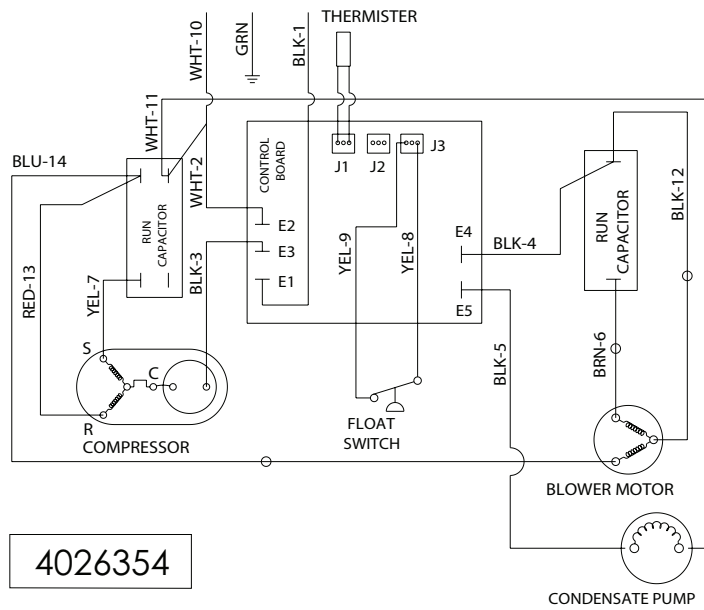

4026354

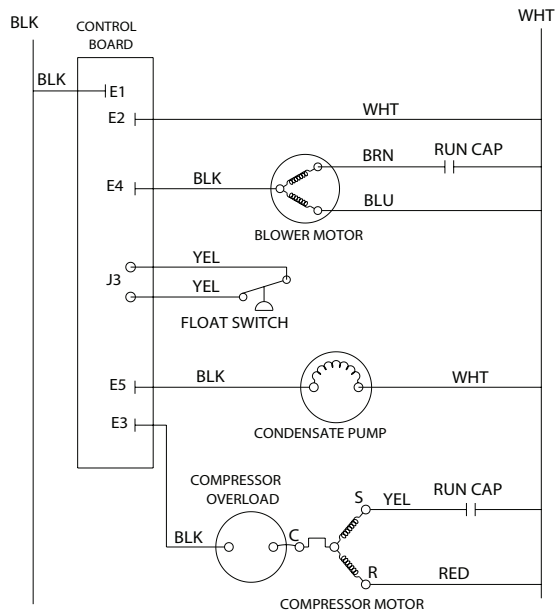

Figure 9: Wiring diagram

8 Service Parts

Item	Description	Qty	Part No.
1	Top Cover	1	4026977
2	Top Cover Hinge	2	4026978
3	Top Cover Catch	1	4026979
4	Hex Bolts, 1/4"-20 x 4"	4	1154019
5	Hex Bolts, 1/4"-20 x 1.75"	2	1154014
6	Handle Assembly	1	4027381
7	Wheel, 12"	2	4026304
8	Cotter Pin	2	1284404
9	Hub Cap, Wheel	1	4027137
10	Filter, 12" x 12" x 1"	1	4026315
11	Hose (1/4" ID x 33' long)	1	4024916
12	Coupling Body, 1/4" Tube	1	4026306
13	Coupling Insert, 1/4" Tube	1	4026986
14	Cord	1	4025078
15	Control Board	1	4026763
16	Capacitor, Compressor, 45 μ F	1	4027108
17	Capacitor, Impeller, 7.5 μ F	1	4024548
18	Thermistor	1	4027278
19	Battery, 9.0 V	1	1912500

Items listed are not shown

Description	Qty	Part No.
Compressor	1	4029168
Evaporator Coil	1	4028234
Condenser Coil	1	4028235
Accumulator	1	4028297
Condensate Pump	1	4026333
Float Safety Switch	1	4026339
Impeller, Air Mover	1	4026360
Exhaust Grill	1	4026308
Wire Duct Collar	1	4026309
Impeller Plate Bolt	4	1154006

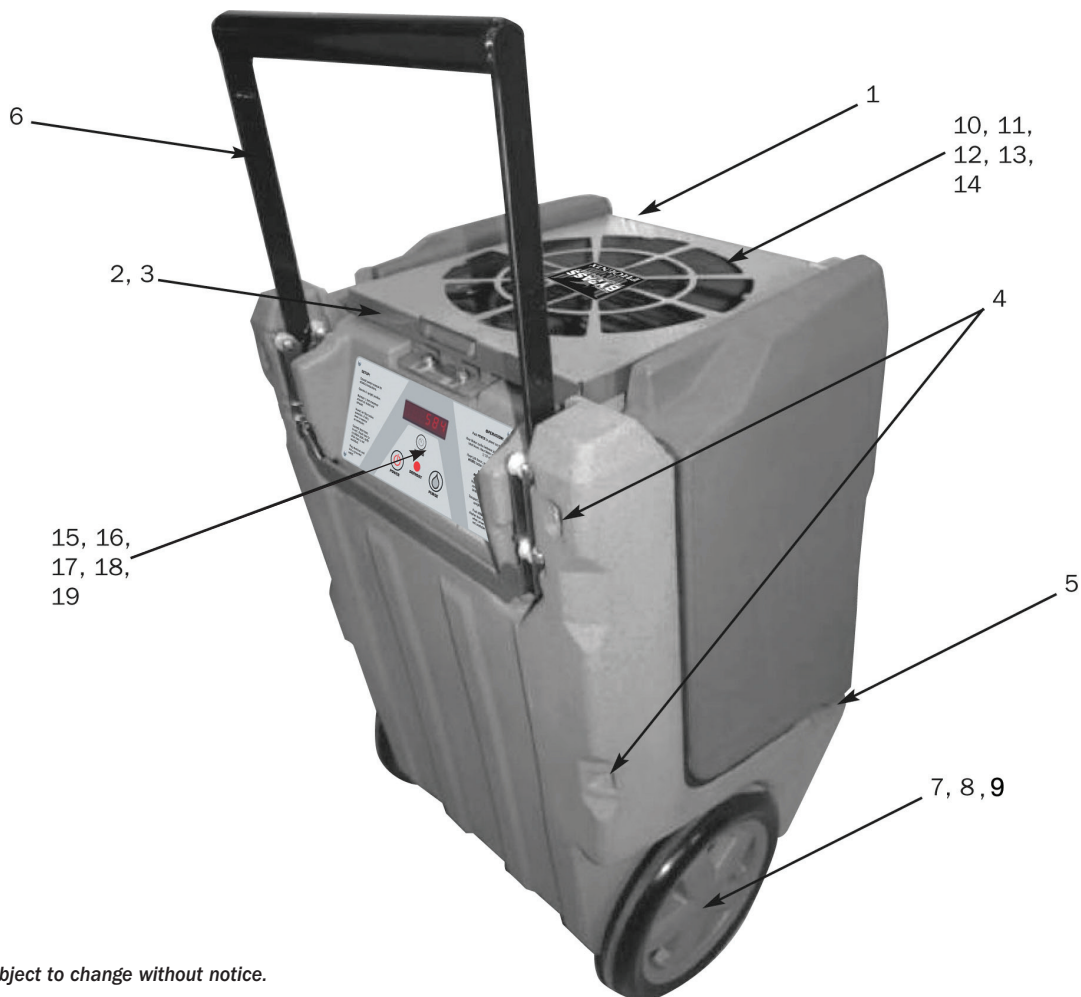

Specifications subject to change without notice.

Phoenix R175 Dehumidifier Limited Warranty

Warrantor:

Therma-Stor LLC
4201 Lien Rd.
Madison, WI 53704
Telephone: 1-800-533-7533

Who Is Covered: This warranty extends only to the original end-user of the Phoenix R175 dehumidifier and may not be assigned or transferred.

Year One: Therma-Stor LLC warrants that, for one (1) year the Phoenix R175 dehumidifier will operate free from any defects in materials and workmanship, or Therma-Stor LLC will, at its option, repair or replace the defective part(s), free of any charge.

Year(s) Two Through Five: Therma-Stor LLC further warrants that for a period of five (5) years, the condenser, evaporator, and compressor of the Phoenix R175 dehumidifier will operate free of any defects in material or workmanship, or Therma-Stor LLC, at its option, will repair or replace the defective part(s), provided that all labor and transportation charges for the part(s) shall be borne by the end-user.

Year(s) One Through Seven: Materials and workmanship of the housing are covered.

End-User Responsibilities: Warranty service must be performed by a Servicer authorized by Therma-Stor LLC. If the end-user is unable to locate or obtain warranty service from an authorized Servicer, he should call Therma-Stor LLC at the above number and ask for the Therma-Stor Service Department, which will then arrange for covered warranty service. Warranty service will be performed during normal working hours.

The end-user must present proof of purchase (lease) upon request, by use of the warranty card or other reasonable and reliable means. The end-user is responsible for normal care. This warranty does not cover any defect, malfunction, etc. resulting from misuse, abuse, lack of normal care, corrosion, freezing, tampering, modification, unauthorized or improper repair or installation, accident, acts of nature or any other cause beyond Therma-Stor LLC's reasonable control.

Limitation and Exclusions: If any Phoenix R175 Dehumidifier part is repaired or replaced, the new part shall be warranted for only the remainder of the original warranty period applicable thereto (but all warranty periods will be extended by the period of time, if any, that the Phoenix R175 Dehumidifier is out of service while awaiting covered warranty service).

UPON THE EXPIRATION OF THE WRITTEN WARRANTY APPLICABLE TO THE PHOENIX R175 DEHUMIDIFIER OR ANY PART THEREOF, ALL OTHER WARRANTIES IMPLIED BY LAW, INCLUDING MERCHANTABILITY AND FITNESS FOR A PARTICULAR PURPOSE, SHALL ALSO EXPIRE. ALL WARRANTIES MADE BY THERMA-STOR LLC ARE SET FORTH HEREIN, AND NO CLAIM MAY BE MADE AGAINST THERMA-STOR LLC BASED ON ANY ORAL WARRANTY. IN NO EVENT SHALL THERMA-STOR LLC, IN CONNECTION WITH THE SALE, INSTALLATION, USE, REPAIR OR REPLACEMENT OF ANY PHOENIX R175 DEHUMIDIFIER OR PART THEREOF BE LIABLE UNDER ANY LEGAL THEORY FOR ANY SPECIAL, INDIRECT OR CONSEQUENTIAL DAMAGES INCLUDING WITHOUT LIMITATION WATER DAMAGE (THE END-USER SHOULD TAKE PRECAUTIONS AGAINST SAME), LOST PROFITS, DELAY, OR LOSS OF USE OR DAMAGE TO ANY REAL OR PERSONAL PROPERTY.

Some states do not allow limitations on how long an implied warranty lasts, and some do not allow the exclusion or limitation of incidental or consequential damages, so one or both of these limitations may not apply to you.

Legal Rights: This warranty gives you specific legal rights, and you may also have other rights which vary from state to state.

